

Steuerstrom
Primärsicherung
0,63A

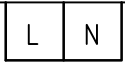

230 V AC
Ausgang

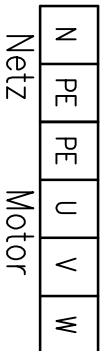
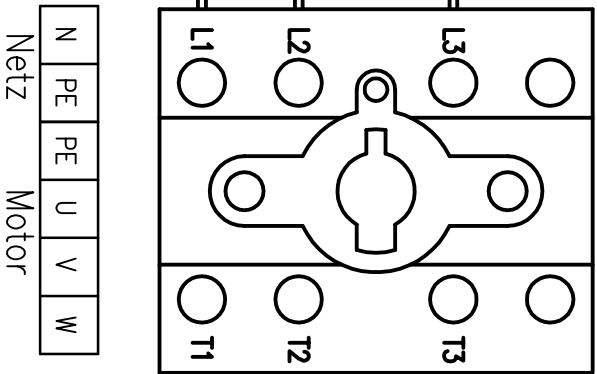

Motor
Anschluß

Netz Einspeisung
in Hauptschalter

Jumper Stellung bei OSE Opto Kontaktleiste
 Jumper Stellung bei EMK oder DW Kontaktleiste*
 *=Vorwiderstand 8,2k erforderlich
 EMK
 COM
 OSE

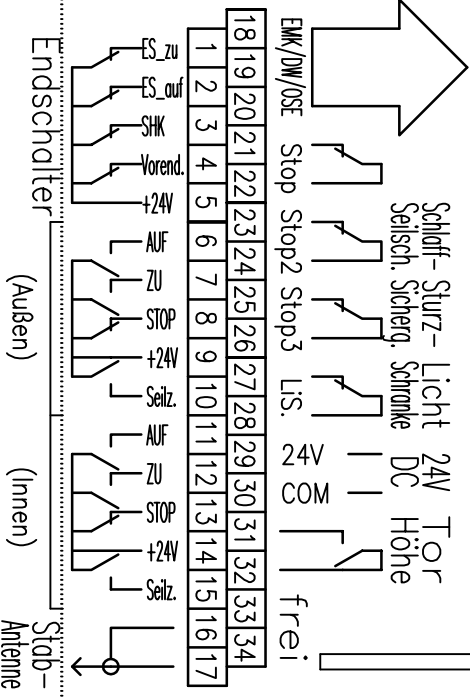
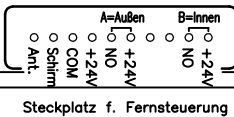
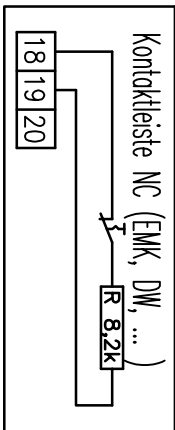
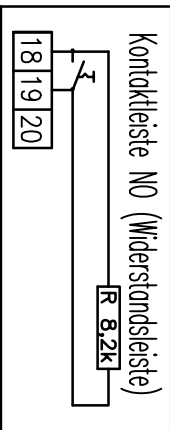
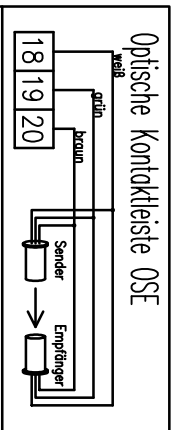
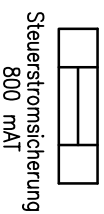
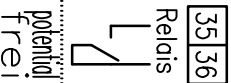
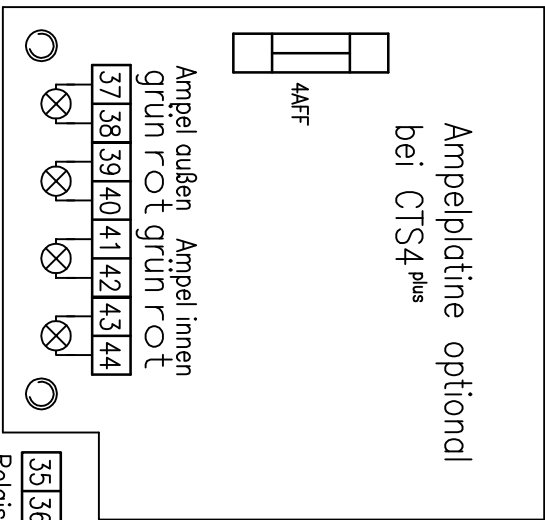

Nicht benötigte Öffner Kontakte brücken!